

標準横断面図

土工部

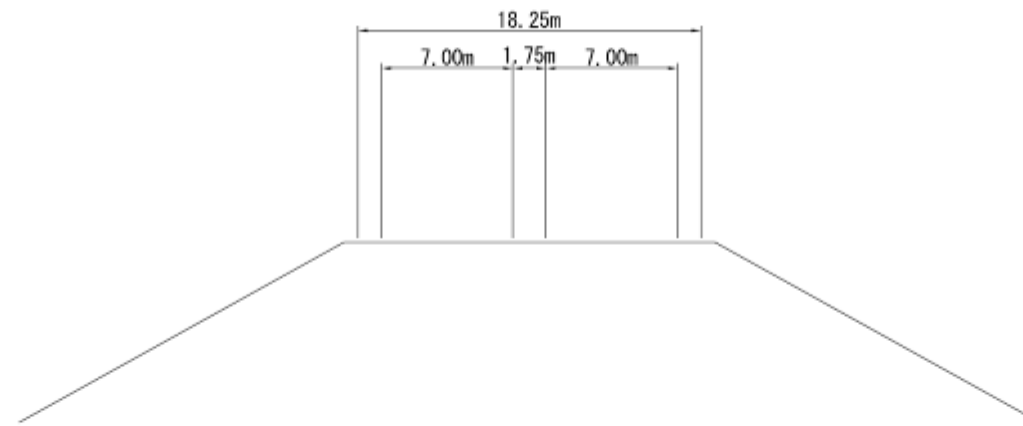

橋梁部

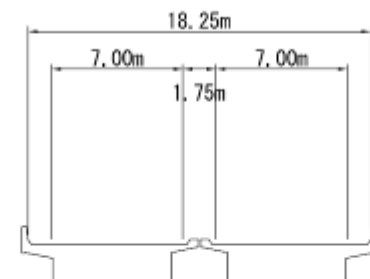

計画図

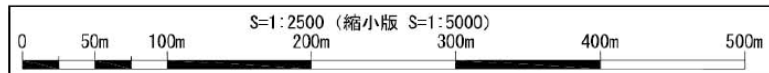
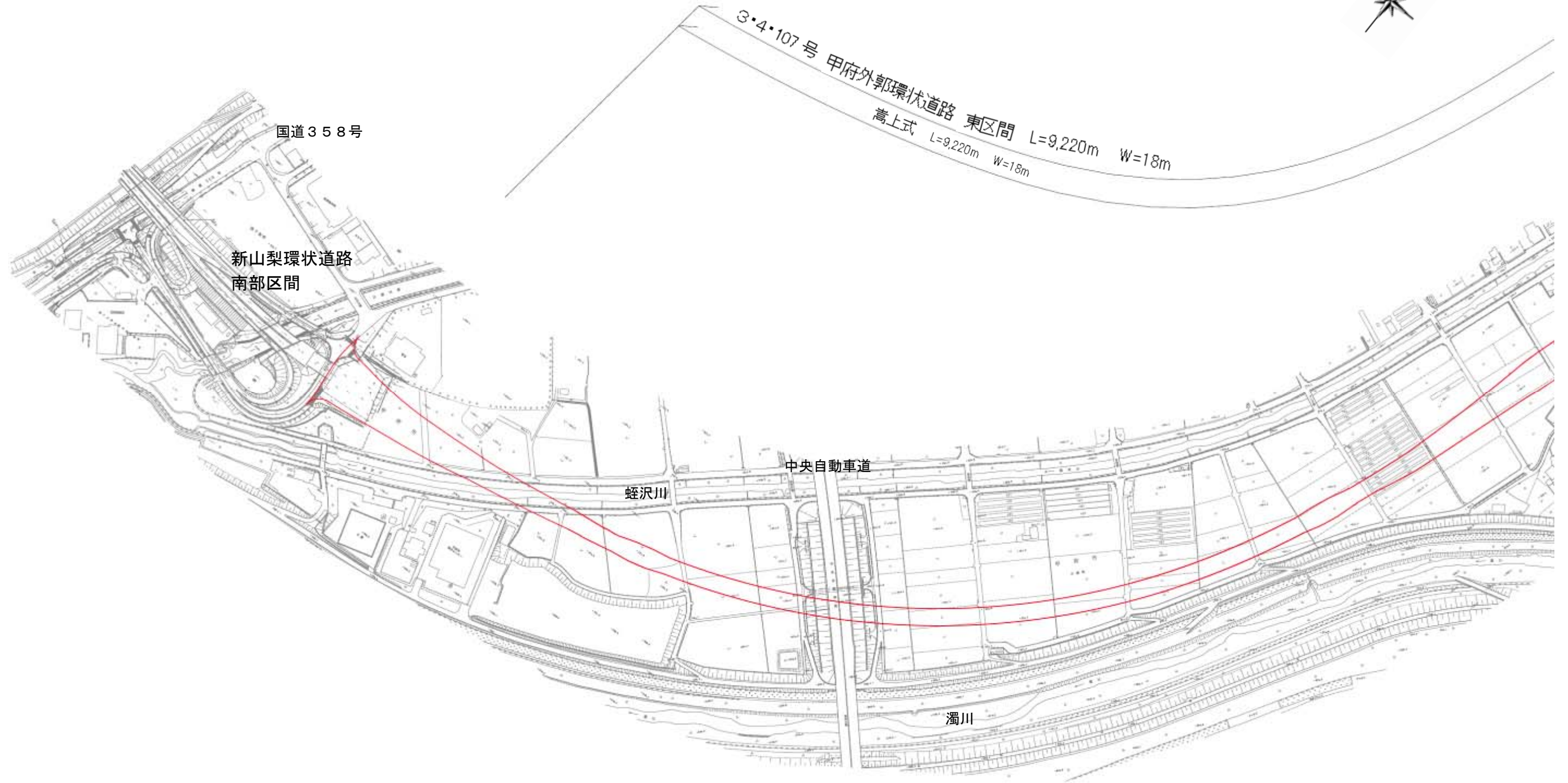

計画図

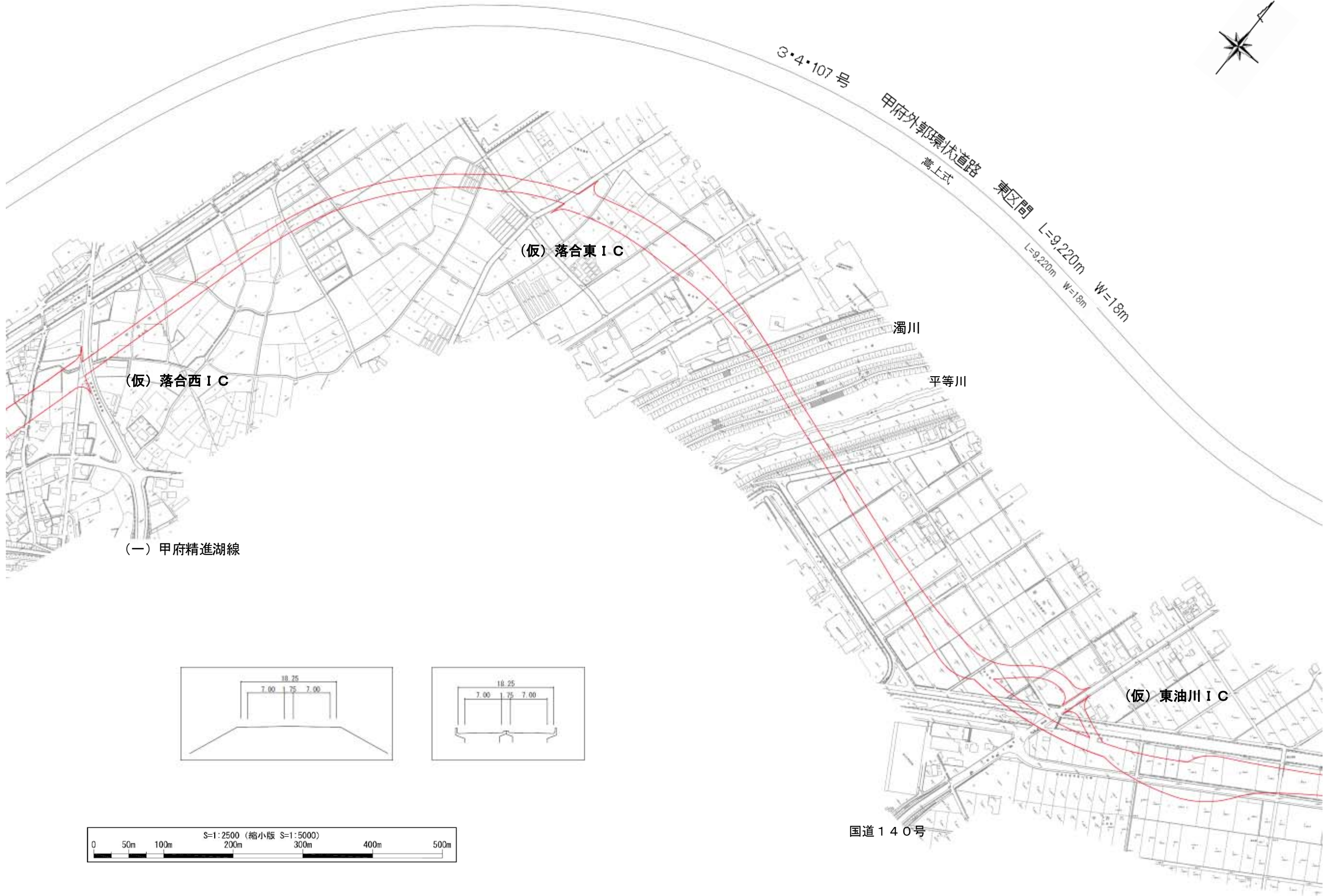

(一) 甲府精進湖線

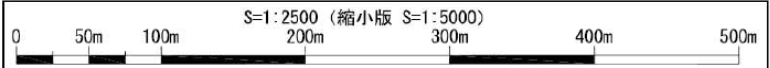
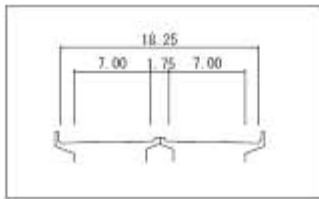
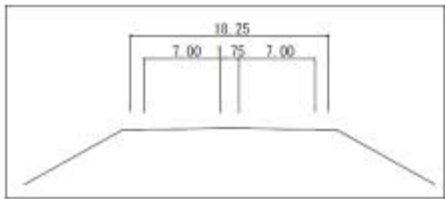

国道140号

計画図

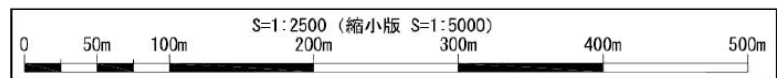
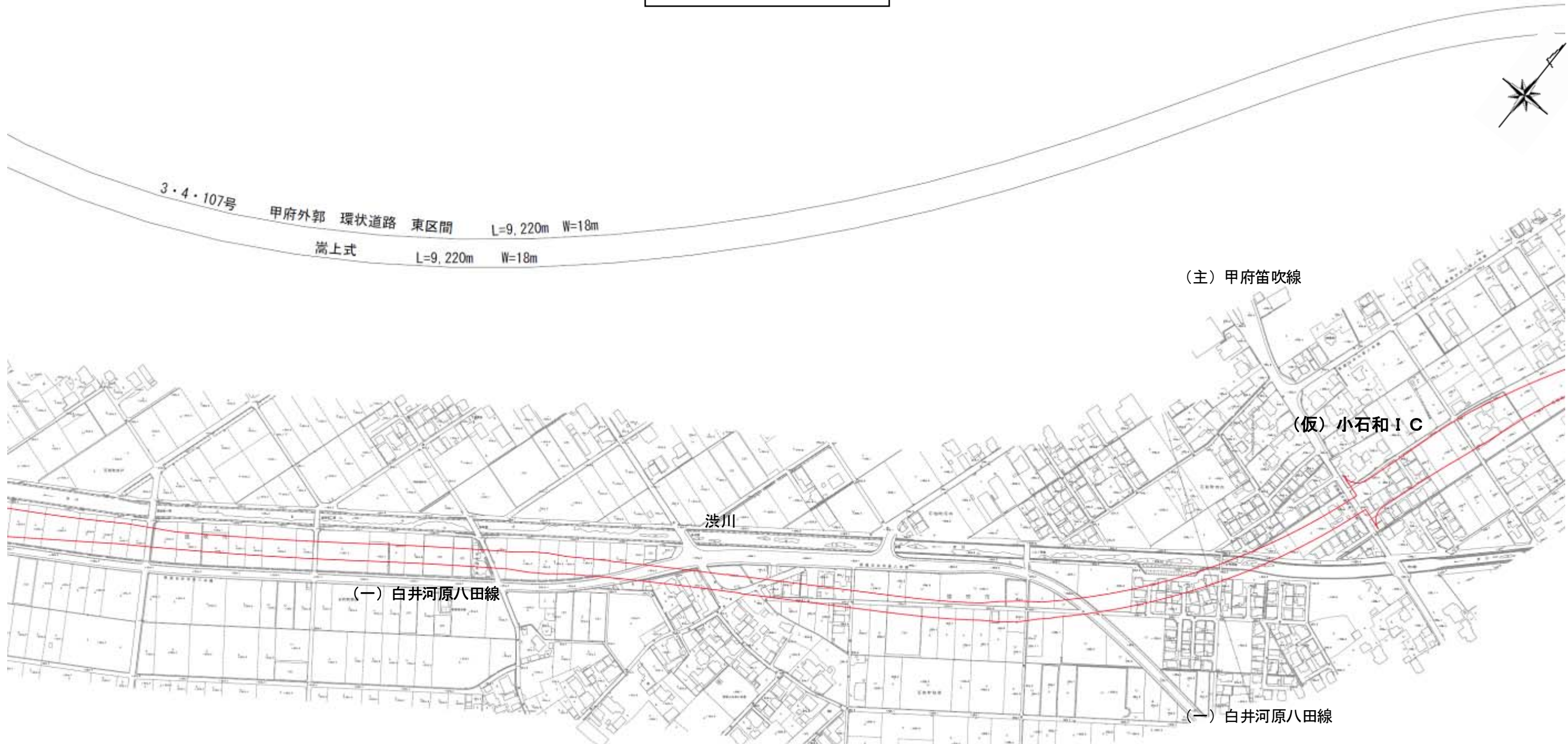

計画図

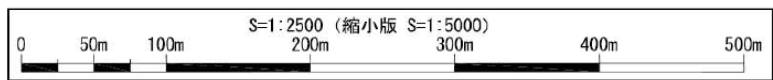

計画図

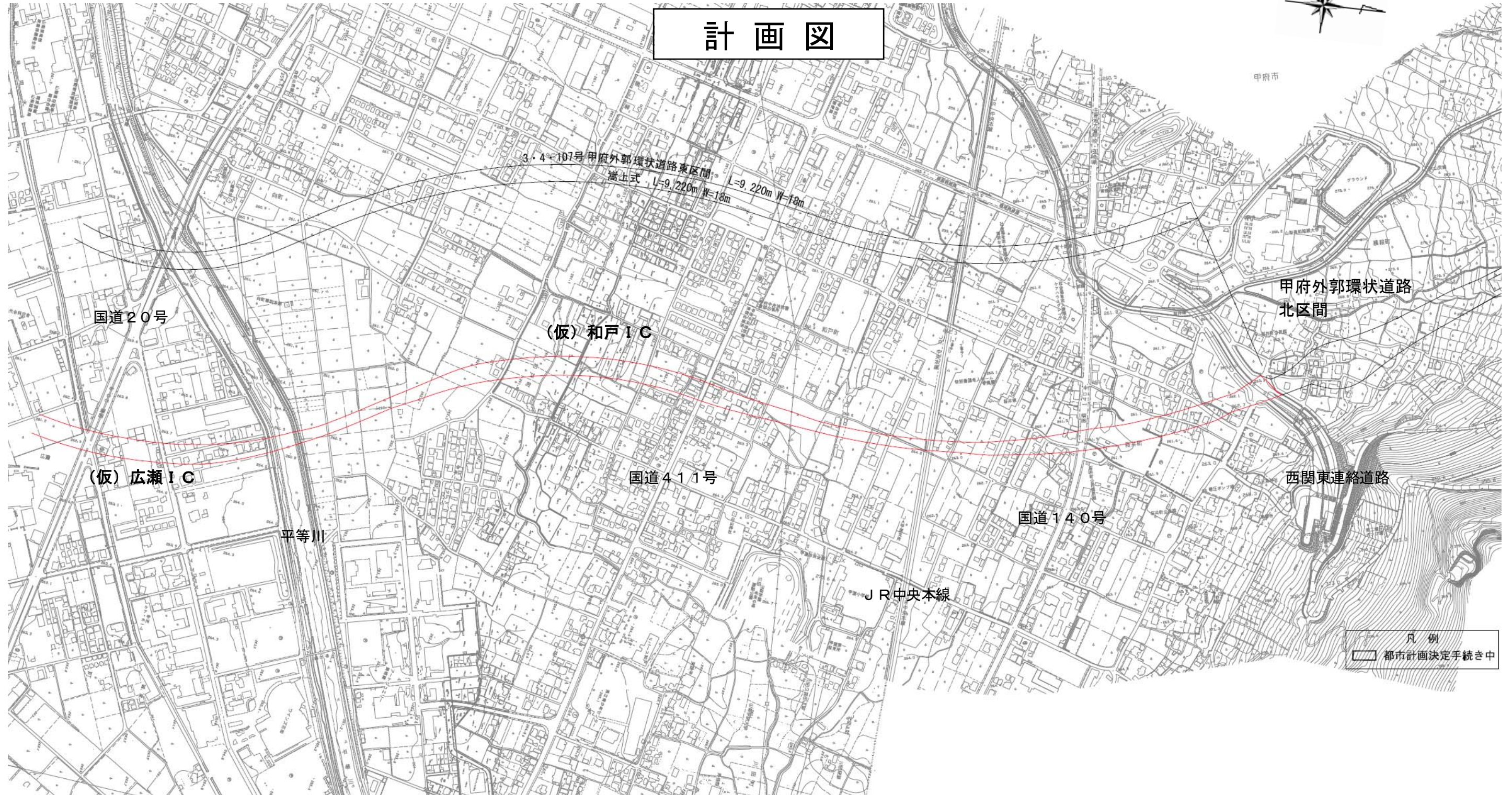

凡例
都市計画決定手続き中

